



# Operating instructions

## Clesana C1

Version 2  
07.09.22

**Clesana AG**  
Werdenstrasse 72  
CH-9472 Grabs  
Email: [info@clesana.com](mailto:info@clesana.com)



## Contents

1. Introduction .....	6
1.1. About this manual .....	6
1.2. Warning signs and symbols .....	6
2. Safety .....	7
2.1. Proper use .....	7
2.2. User qualification .....	7
2.3. Operation .....	7
2.4. Cleaning and maintenance .....	8
2.5. Modifications and repairs .....	8
2.6. Residual risks .....	8
2.6.1 Live parts .....	8
2.6.2 Burning or pointed objects .....	8
2.6.3 Water ingress .....	8
2.6.4 Moving parts .....	9
2.6.5 Harmful substances .....	9
3. Design and function .....	10
3.1. Overview .....	10
3.2. Control panel .....	12
3.3. Display .....	13
4. Preparation .....	14
4.1. Check the status of the toilet .....	14
4.2. Insert or change the foil liner .....	14
5. Operating steps after the toilet trip .....	16
5.1. Use the absorber for fluid binding .....	16
5.2. Note the filling level .....	16
5.3. Start flushing process .....	17
6. Optional operating steps .....	19
6.1. Perform manual bag separation .....	19
6.2. Interrupt the flushing process .....	20



6.3. Restart the toilet .....	21
7. Cleaning and maintenance .....	22
7.1. Cleaning .....	22
7.2. Change the Teflon tapes .....	22
8. Maintenance .....	23
9. Troubleshooting .....	24
10. Error codes .....	26
11. FAQ .....	28
12. Disposal and the environment .....	29
13. Technical specifications .....	29



## 1. Introduction

### 1.1. About this manual

These operating instructions familiarise you with the characteristics and functions of the waterless toilet Clesana C1. The manual contains important information for the correct and safe handling of the toilet.

- ▶ Read these operating instructions carefully before the initial start-up.
- ▶ Keep this manual safe so that the information is available at all times.

This manual is continuously improved, but it may happen that document enclosed with Clesana C1 does not correspond to the current version. We recommend that you check on our website <https://clesana.com/info-area> whether there a newer version of this manual is available.

### 1.2. Warning signs and symbols

Warning signs are used in this manual in order to alert you against property damage and personal injuries.

Warning symbol	Warning word	Meaning
	CAUTION	Hazards for persons. Non-compliance can result in minor injuries.
–	NOTE	Information for avoiding property damage.

Symbol	Meaning
	Important information, e.g. for better comprehension or for facilitating work processes
	Action steps that you must perform
	Measures for avoiding hazard in a warning sign
1., 2.	Several action steps that you must perform in the order specified
	Result indication of an action step or several action steps
(⇒ page, "Chapter")	Reference to a chapter of the manual
	Important details in graphics
	Motion sequences in graphics



## 2. Safety

This chapter contains important information on safety of the device. Read the safety instructions thoroughly before start-up and operation.

### 2.1. Proper use

The waterless toilet Clesana C1 is intended to be used for sanitary bagging of excrements and personal hygiene articles. Bagging of nappies or biowaste is also possible. Different uses are not allowed. The device is intended exclusively for non-public areas.

#### Possible misuse

Not intended use of the device can result in property damage and personal injuries. For example, the device is not suitable for the following uses:

- Bagging of pointed or sharp-edged objects (e.g. broken glass, needles, razor blades)
- Bagging of burning or red hot objects (e.g. Ashes, cigarettes, matches)
- Bagging of liquids and chemicals that could react with the bag
- Bagging of foodstuffs or organisms
- Use as climbing aid

### 2.2. User qualification

Persons, children and people with physical, sensory or mental disabilities not familiar with the device should use the Clesana C1 only under the supervision or according to the instructions of a responsible person.

Maintenance works must be carried out by authorised qualified persons. Contact your dealer if needed.

### 2.3. Operation

- ▶ Regularly check that all functions are carried out correctly.
- ▶ After each use and before leaving the Clesana C1 unattended, make sure that the flushing process is completed and that the toilet is ready for use.
- ▶ Never operate the Clesana C1 without correctly mounted lid and fully inserted tray.

The Soft-Close mechanism closes the toilet lid automatically. This mechanism will be damaged if the lid is manually pressed downwards.

- ▶ Never press the toilet lid downwards.
- ▶ Never use the toilet without inserted foil liner.



## 2.4. Cleaning and maintenance

- ▶ Perform only the cleaning works described in these operating instructions and note the associated safety instructions.
- ▶ Do not clean the toilet with running water.

Clesana foil liners ensure a reliable functioning of your Clesana C1. The use of other foil liners can result in malfunctions.

- ▶ Use only Clesana foil liner.

## 2.5. Modifications and repairs

Repairs not properly carried out can result in accidents and property damage.

- ▶ Do not open the base body.
- ▶ Do not install any additional components and do not make any modifications to the device.
- ▶ Contact your dealer if a defect is suspected.

## 2.6. Residual risks

### 2.6.1 Live parts

Opening the base body can expose the live parts. There is a risk of life threatening electrocution.

- ▶ Do not open the base body.

### 2.6.2 Burning or pointed objects

Burning objects ignite the foil bag and cause fires. Pointed objects damage the foil bag, soiling the tray.

- ▶ Do not dispose of any burning materials such as cigarettes, matches or hot ashes in the toilet.
- ▶ Do not dispose of pointed or shape-edged objects in the toilet.

### 2.6.3 Water ingress

Water can penetrate in the inside of the toilet through a not closed lid or a not correctly inserted tray, cause a short-circuit and damage the electronic control or the welding mechanism. This may result in malfunctions and damage to the components.

- ▶ Do not expose the Clesana C1 to jet water (e.g. when taking a shower).
- ▶ Use the toilet only when seated.
- ▶ Never operate the Clesana C1 in a wet room without the lid properly placed and fully inserted tray.
- ▶ If the welding unit comes into contact with water: Let the toilet to dry for 24 hours without inserted foil liner.



### 2.6.4 Moving parts

The Clesana C1 has a rotating mechanism for optimal positioning. If the area around the toilet is obstructed by objects, the rotating of the toilet may result in crushing of fingers.

- ▶ Keep the surroundings of the toilet free of objects.

### 2.6.5 Harmful substances

Swallowing the absorber can lead to nausea and stomach discomfort. Eye contact can pose the risk of severe eye irritation.

- ▶ Keep the absorber away from the reach of children.
- ▶ Note the safety data sheet of the absorber, available on the website: <https://clesana.com/info-area>.
- ▶ In the event of eye contact, rinse the eyes with running water for several minutes.
- ▶ If you have swallowed the absorber, rinse your mouth with water and drink up plenty of water.
- ▶ See a physician in case of persistent discomfort.



## 3. Design and function

### 3.1. Overview

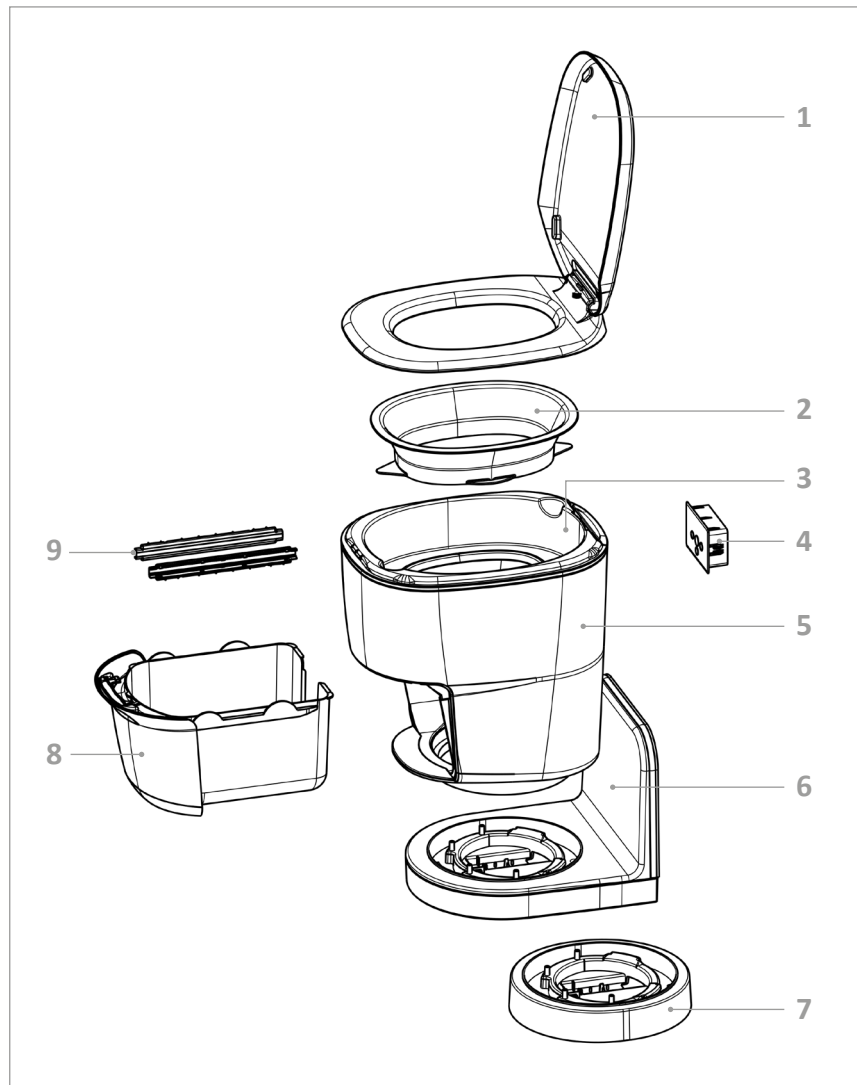

No.	Description	Function
1	Lid/Seat	<ul style="list-style-type: none"><li>Covering of the foil compartment</li><li>Protection against entry of jet water</li></ul>
2	Foil cassette	Mounting of the foil liner
3	Foil compartment	<ul style="list-style-type: none"><li>Replica of a toilet bowl</li><li>Guiding the foil to the welding mechanism</li></ul>
4	Control Panel/Display	<ul style="list-style-type: none"><li>Toilet control</li><li>Display of the remaining toilet uses with the inserted foil liner</li><li>Display of operating status and error codes</li></ul>
5	Housing/Base body	Mounting of lid/seat, foil cassette, Teflon tape and tray
6	L-Adapter	<ul style="list-style-type: none"><li>Placing the toilet on the wall</li><li>Mounting the toilet on the floor</li><li>Covering the existing openings in the wall, e.g. due to a previously installed toilet</li></ul>
7	Round base	Placing and free mounting of the toilet in the room
8	Tray	Collects up to 6 bags. This corresponds to 2 bag chains with 3 bags each.
9	Teflon tape ((PTFE Tapes)	Preventing the sticking and tearing of welding seam in the welding process

The Clesana C1 is the first mobile waterless toilet which operates based on the bag-welding principle. After each toilet trip the toilet welds the toilet content in a separate foil bag.

The foil bag is made of a multiple-folded continuous foil, the foil liner, previously mounted on the foil cassette (2) and is inserted in the foil compartment (3). The foil bag replicates a toilet bowl.

Once the flushing process is triggered via the control panel (4) the toilet pulls the foil from the foil cassette (2) automatically, welds it and prepares for the next use of the toilet.

The odour-proof closed foil bags are collected in the tray (8).



### 3.2. Control panel

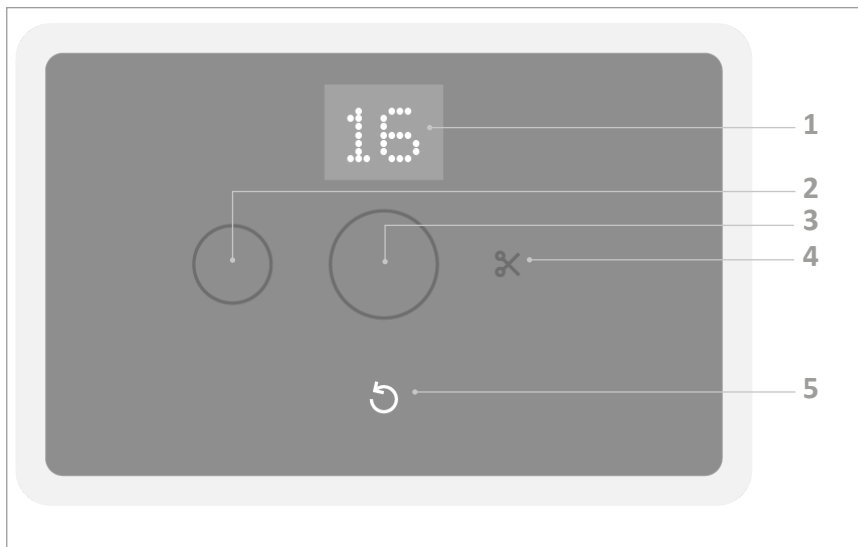

No.	Description	Function
1	Display	Display of the remaining large flushing processes
2	“Small flushing process” button	<ul style="list-style-type: none"> <li>Press once: Triggering of a small flushing process</li> <li>Press twice: Triggering of an extra small flushing process</li> </ul>
3	“Large flushing process” button	<ul style="list-style-type: none"> <li>Press once: Triggering a large flushing process</li> <li>Press twice: Triggering of an extra large flushing process</li> </ul>
4	“Separate” button	Creating a single bag with subsequent pressing of buttons (2) or (3)
5	Arrow button	<ul style="list-style-type: none"> <li>Resetting the counter/display after replacing the foil liner</li> <li>Interruption of the flushing process</li> </ul>



### 3.3. Display

	<p><b>The toilet is ready for operation.</b></p> <ul style="list-style-type: none"> <li>Displayed numbers stand for the still available “Large flushing processes”.</li> <li>From a number of “3”, the display lights up in red to indicate the imminent ending of the foil liner.</li> </ul>
	<p><b>The toilet is not ready for operation.</b></p> <p>The toilet lid is not properly closed.</p> <ul style="list-style-type: none"> <li>Close the toilet lid.</li> <li>If the display persists, perform a troubleshooting (⇒ Page 24, “9. Troubleshooting”).</li> </ul>
	<p><b>The toilet is not ready for operation.</b></p> <p>There is not enough foil available.</p> <ul style="list-style-type: none"> <li>Insert a new foil liner (⇒ Page 14, “Insert or change the foil liner”).</li> <li>If the display still persists preform a troubleshooting (⇒ Page 24, “9. Troubleshooting”).</li> </ul>
	<p><b>The toilet is not ready for operation.</b></p> <p>There is a fault in the welding unit.</p> <ul style="list-style-type: none"> <li>Perform a Troubleshooting (⇒ Page 24, “9. Troubleshooting”).</li> </ul>
	<p><b>The toilet is not ready for operation.</b></p> <p>The tray must be emptied.</p> <ul style="list-style-type: none"> <li>Empty the tray.</li> <li>If the display persists, perform a troubleshooting (⇒ Page 24, “9. Troubleshooting”).</li> </ul>
	<p><b>The toilet is not ready for operation.</b></p> <p>The battery voltage is too low.</p> <ul style="list-style-type: none"> <li>Perform a Troubleshooting (⇒ Page 24, “9. Troubleshooting”).</li> </ul>
	<p><b>The toilet is not ready for operation.</b></p> <ul style="list-style-type: none"> <li>Perform a troubleshooting using the error codes (⇒ Page 26, “10. Error codes”).</li> </ul>
	<p><b>Status display of the process flow</b></p> <p>The process is stopped if the lid or the tray is opened during the running process.</p> <ul style="list-style-type: none"> <li>Wait until the process is completed.</li> </ul>



## 4. Preparation

### 4.1. Check the status of the toilet



The display shows the theoretically available number of large bags. If the content in the foil compartment is heavier than 500 g, the weight can pull down the foil liner and falsify the number on the display.

For technical reasons, a low residual foil always remains on the foil liner.

- ▶ Check that there is enough foil for a complete bag before each use of the toilet and in particular when the display shows less than 5 available bags.
- ▶ Make sure that there is always enough refill foil liner near the Clesana C1.

### 4.2. Insert or change the foil liner

1. Press the rear tab of the lid unit forward (2) and lift it upwards with both hands (2).

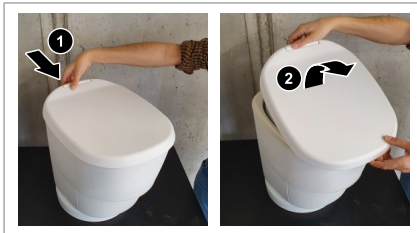

2. Take the foil cassette out of the toilet and lay it upside down on an even surface.



3. Place the foil liner over the foil cassette. The protruding part of the foil liner points downwards.



4. Rotate the foil cassette and pull the protruding foil approx. 10 cm upwards.



5. Reinsert the foil cassette with the protruding foil pointing upwards in the foil compartment. Make sure no foil is jammed between the foil compartment and the foil cassette.



6. Pull the foil upwards until you see at least 4 visible folds.



7. Fold the foil inwards and distribute it evenly in the foil compartment.



8. Place the lid unit by fixing it in the front area (1) and then snapping it in the groove in the rear area of the Clesana C1 (2).



9. Press and hold the arrow button on the control panel for 3 seconds.

↳ The foil tube is welded.

↳ The counter is reset.

↳ The toilets is ready for operation.

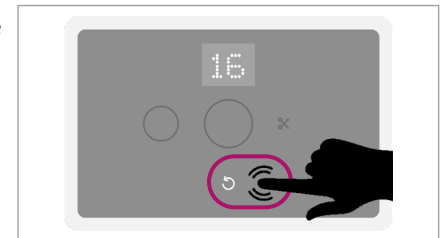



## 5. Operating steps after using the toilet

### 5.1. Use the absorber for fluid binding

#### ⚠ CAUTION! Health impairment through improper use.

- ▷ Do not swallow the absorber.
- ▷ Do not allow the absorber to come into contact with the eyes.

For binding the fluids (e.g. urine) we recommend the use of Clesana Super Absorber. The powder shell dissolves upon coming into contact with the fluids. The powder binds the fluids in the foil bag.

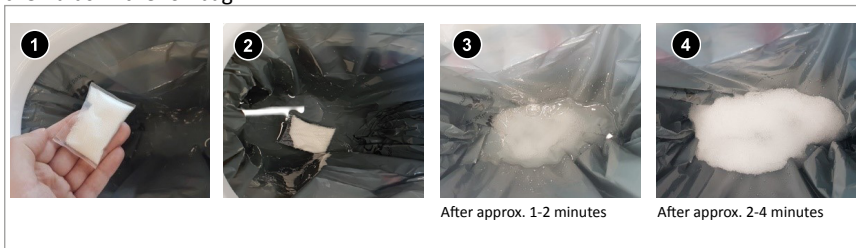

- ▶ Insert a bag in the foil compartment before or after toilet trip.

### 5.2. Note the filling level

⚠ Toilet paper should not be over the prescribed maximum filling level, otherwise the welding can be interrupted.

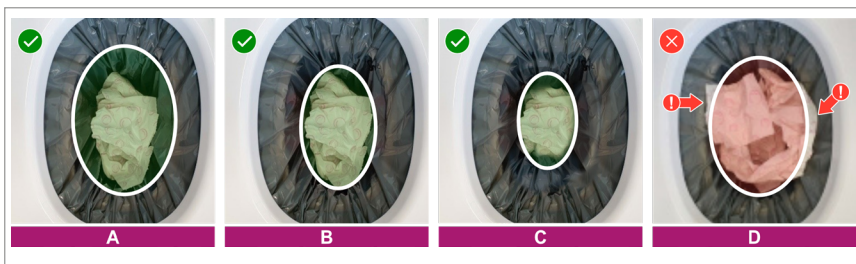

- A Maximum filling level of a large bag
- B Maximum filling level of a small bag
- C Maximum filling level of an extra small bag
- D Exceeding the maximum filling level

- ▶ Note the correct position of the toilet paper:
  - **A:** With large bags below the white plastic ring shining through the foil
  - **B:** With small bags below the upper transport rollers
  - **C:** With extra small bags below the welding jaws



### 5.3. Start flushing process

During the flushing process the individual bags are separated from each other by welding. After three bags the bag chain is automatically separated from the foil liner and falls into the tray.

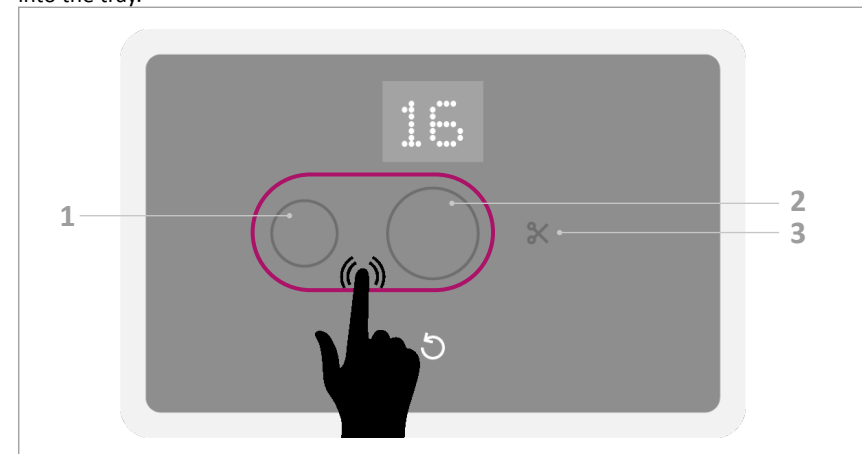

Fig. 1: Select small or large flushing process on the control panel

- 1 "Small flushing process" button
- 2 "Large flushing process" button
- 3 "Separate" button

1. Check the filling level of the toilet (⇒ Page 16, "5.2. Note the filling level").
2. Close the toilet lid.
3. Select the bag size on the control panel with button (1) or (2):

Bag size	Button	Bag length	Max. bag per liner	Recommended
"Small"	1 x Flushing process small	approx. 20cm	38	"Small business" and "large business" with less paper
"Large"	1 x Flushing process large	approx. 30cm	26	"Large business" with normal paper quantity
"Extra small"	2 x small flushing process, within 2 s	approx. 15cm	50	"Small business" without paper
"Extra large"	2 x large flushing process, within 2 s	approx. 40cm	19	"Large business" with lots of paper. Is separated automatically.

- ↳ The flushing process is started.
- ↳ Selected button (1) or (2) flashes.
- ↳ The additional button (3) is flashing while the bag chain is separated automatically.



- Wait until all buttons of the control panel light up.
  - The flushing process is completed.

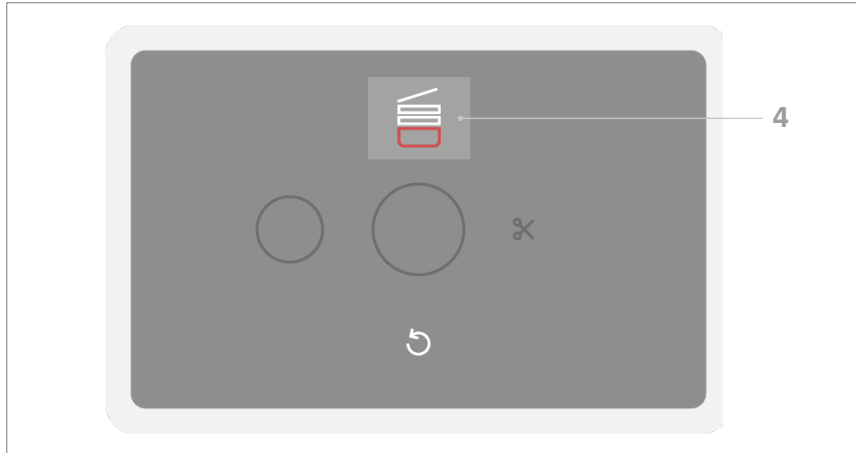

Fig. 2: Empty the tray after the separation of the second bag chain

- If the second bag chain is separated automatically, follow the prompt on the display (4) and empty the tray.



## 6. Optional operating steps

### 6.1. Perform manual bag separation

With this function you can separate the bag from the foil liner after flushing process and can remove it directly out of the tray.

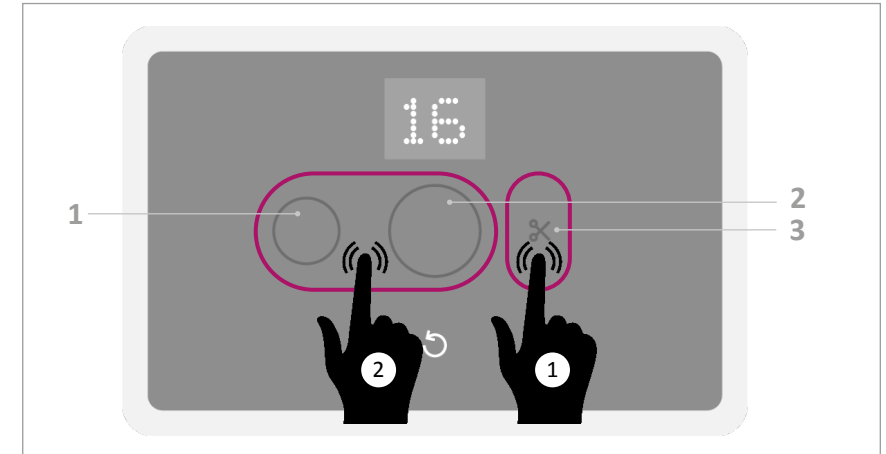

Fig. 3: Perform manual bag separation

- Check the filling level of the toilet (⇒ Page 16, “5.2. Note the filling level”).
- Close the toilet lid.
- Press and hold for 3 seconds one after the other the button (3), followed by button (1) or (2), depending on the bag size you wish to use.
  - The flushing process is started.
  - Button (3) and selected button (1) or (2) flashes.
- Wait until all buttons of the control panel light up.
  - The flushing process is completed.
  - The filled and welded bag is separated and is in the tray.

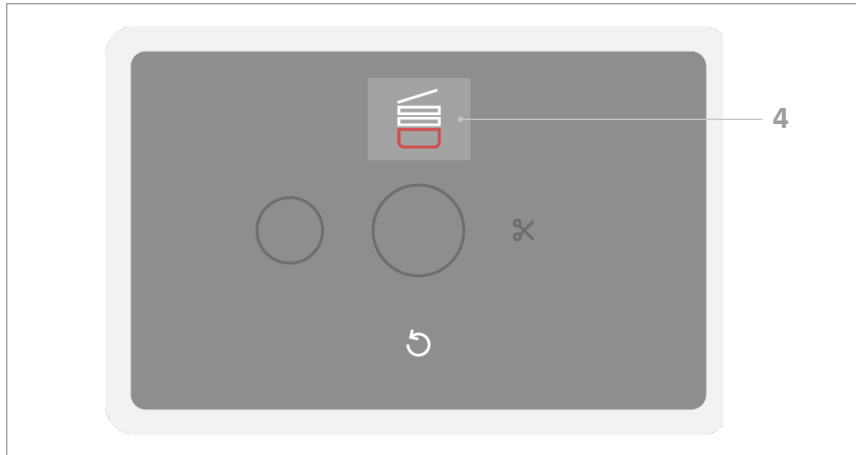

Fig. 4: Empty the tray after manual separation of the bag chain

5. Follow the prompt on the Display (4) and empty the tray.

## 6.2. Interrupt the flushing process

With this function you can interrupt the welding or separation process any time, e.g. if you have selected the incorrect bag size on the control panel. The welding jaws return to the start position after the interruption.



If the foil has been transported before the program interruption, the counter on the Display is adjusted accordingly.

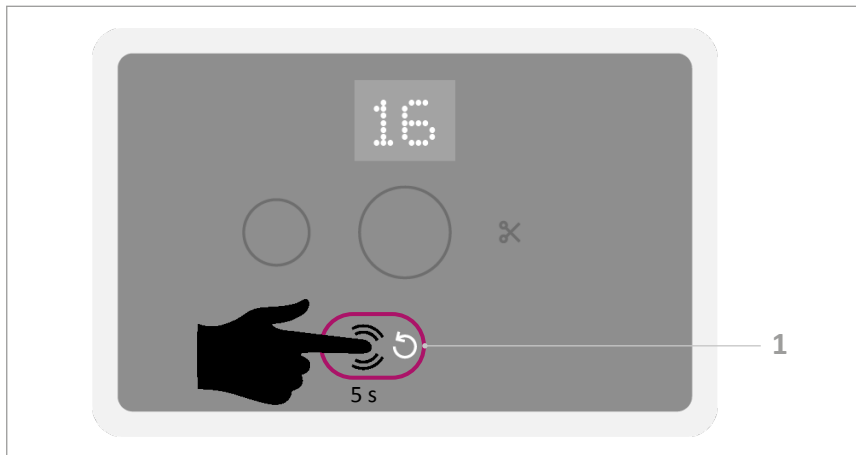

Fig. 5: Interrupt the flushing process



1. Press and hold the arrow button (1) for 5 seconds, while a process is in progress.
  - ↳ Message “E6” appears on the Display.
2. Confirm the message by pressing the arrow button (1).
3. Wait until all buttons of the control panel light up.
  - ↳ The program interruption is completed.

## 6.3. Restart the toilet

You can restart the toilet if the control panel does not respond or if there is an error. The number of remaining toilet trips is stored.

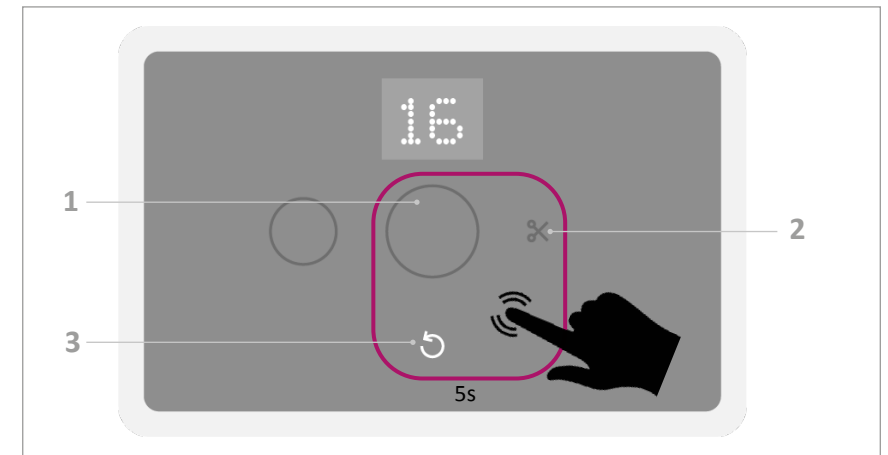

Fig. 6: Restart the toilet

1. Press and hold for 5 seconds simultaneously the arrow button (3), the “Flushing process” button (1) and the “Separate” button (2).
  - ↳ The toilet restarts.
2. Wait until all buttons of the control panel light up.
3. If the error persists, perform a troubleshooting (⇒ Page 24, “9. Troubleshooting”).



## 7. Cleaning and maintenance

### 7.1. Cleaning

#### NOTE! Damage to the toilet through improper cleaning.

- ▷ Do not clean the toilet with running water (e.g. With a hose).
- ▷ If the welding unit comes into contact with water: Let the toilet to dry for 24 hours without inserted foil liner.
- ▷ Do not use bleach.

Since the Clesana C1 operates without water, and the “Foil bowl” is renewed with each use, it is very low maintenance. We recommend however to clean the following components regularly with a moist cloth and commercially available cleaning materials:

- Toilet seat
- Toilet lid
- Foil compartment
- Base body

### 7.2. Change the Teflon tapes



Both Teflon tapes must always be changed at the same time.

After approx. 1500 weldings resp. separations the non-stick coating of the Teflon tapes over the welding wires loses its effectiveness. The loss of the non-sticking effect leads to problems in the transport and the welding of the plastic foil.

#### Remove the Teflon tapes

1. Take the foil cassette out of the toilet.
2. Close the toilet lid.
3. Press the “Flushing process” button on the control panel and open the toilet lid after approx. 2 seconds.
  - ↳ The flushing process is interrupted.
  - ↳ The distance between the welding jaws is 6 to 10 cm.

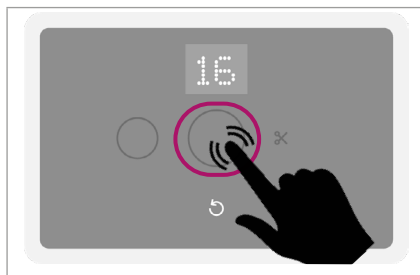

4. Insert the tip of a slotted screwdriver in the recess and lever the first Teflon tape out of the guide.
5. Repeat the process for the second Teflon tape.
6. Dispose of the removed Teflon tap in the household waste.

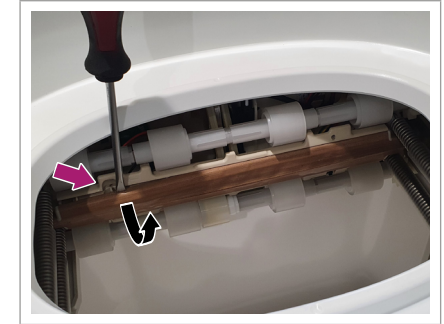

#### Insert the Teflon tapes

#### NOTE! Damage to the welding mechanism due to falling off of the Teflon tape

If previously removed Teflon tapes are used again they can fall off due to the worn retaining lug. The welding mechanism might be damaged if the welding process is performed without Teflon tapes.

- ▷ Do not use any previously removed Teflon tapes.

1. Make sure that when mounting the Teflon tapes all retaining lugs are snapped into place and are not damaged.
2. Click the first Teflon tape in the guide rail.
3. Repeat the process for the second Teflon tape.
4. Close the toilet lid.
  - ↳ The welding jaws return to their original position.
  - ↳ The toilets is ready for use.

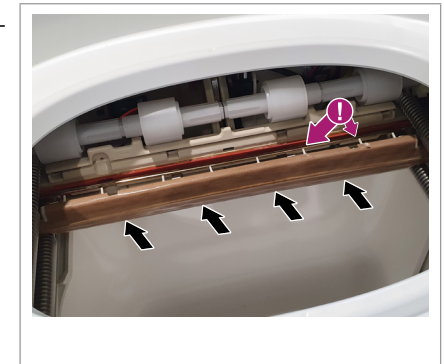





## 8. Maintenance

- ▶ Maintenance should be carried out only by authorised qualified personnel, ideally by the dealer / manufacturer from whom you have purchased the Clesana C1.



## 9. Troubleshooting

Fault	Display	Possible Cause	Remedy
The toilet cannot be used		Battery voltage < 11.8 V	► Charge the vehicle battery.
		The lid is open or is not mounted.	► Close or mount the lid or the lid unit.
		The magnets of the lower rubber pads of the lid are missing.	► Reinsert the magnets.
		The tray is not inserted or is full.	► Close or empty the tray (the tray must be open more than 2 seconds).
		The magnets behind the tray have fallen out of their seat.	► Reinsert the magnets.
	No more foil in the foil compartment.	► Replace the foil liner ((⇒ Page 14, "Insert or change the foil liner"))).	
The control panel does not light up	—	The toilet is in standby.	► Open/close the lid or press any button.
		There is no voltage.	► Check the circuit breaker or the relay and the battery voltage.
		The control panel or the toilet is defective.	► Contact your dealer.
The bag is leaking	—	There is foreign object in the welding seam e.g. Toilet paper.	► Use less paper or press it further downwards ((⇒ Page 16, "5.2. Note the filling level"))).
		The Teflon tape is defective, worn or loose.	► Press on the Teflon tape. ► Replace the Teflon tape if needed (⇒ Page 22, "7.2. Change the Teflon tapes").
		Defective welding rod	► Contact your dealer.
Separation not successful	—	There is foreign object in the welding seam e.g. Toilet paper.	► Remove object or use less paper or press it further downwards.
		The welding rod is defective.	► Contact your dealer.



The bag sticks to the Teflon tape	—	The Teflon tape is worn out.	► Replace both Teflon tapes (⇒ Page 22, "7.2. Change the Teflon tapes").
The length of the bag is irregular	—	The foil is jammed between the foil compartment and the cassette.	1. Remove the foil cassette. 2. Check the foil cassette and reinstall properly.
		The bag length varies with content and filing process.	► No correction needed.
The bag wraps itself around the transport rollers	—	The bags accumulate in the tray and are pulled upwards and in the transport rollers.	1. Remove the foil from the transport rollers. 2. Empty the tray and pull new foil downwards. 3. Press the "Small flushing process" button.
		The foil sticks to the Teflon tape.	1. Loosen the foil from the Teflon tape. 2. Replace the Teflon tape if needed (⇒ Page 22, "7.2. Change the Teflon tapes").



## 10. Error codes

Error	Cause	Troubleshooting
<b>E1</b>	The toilet does not initialize.	▶ Switch the power off and on again.
<b>E2</b>	The toilet lid has been opened during the process.	▶ Close the lid. ↳ The process continues.
<b>E3</b>	The tray has been opened during the process.	▶ Close the tray. ↳ The process is continued.
<b>E4</b>	Voltage drop below 8.4V on the printed circuit board	1. Press the arrow button to confirm. 2. Have the C1 power supply checked by your dealer.
<b>E5</b>	The battery voltage is less than 11.8V	1. Press the arrow button to confirm. 2. Charge the battery.
<b>E6</b>	Confirm program abort	▶ Press the arrow button to confirm.
<b>E8</b> <b>E9</b>	Light barrier error	▶ Restart the toilet (⇒ Page 21, “6.3. Restart the toilet”).
<b>E10</b> <b>E11</b>	Motor error	▶ Restart the toilet (⇒ Page 21, “6.3. Restart the toilet”).
<b>E12</b>	Overcurrent on the left welding jaw motor, possible object between the welding jaws	1. Press the arrow button to confirm. 2. Open the lid and check for jammed objects.
<b>E13</b> <b>E14</b>	Error on the left welding jaw motor	▶ Press the arrow button to confirm.
<b>E15</b>	Overcurrent on the right welding jaw motor, possible object between the welding jaws	1. Press the arrow button to confirm. 2. Open the lid and check for jammed objects.
<b>E16</b> <b>E17</b>	Error on the right welding jaw motor	▶ Press the arrow button to confirm.
<b>E18</b>	Overcurrent on upper roller motor, possible foil wrapping	1. Open the lid and check the upper rollers. 2. If needed, remove the wrapped foil from the roller. 3. Close the lid.
<b>E19</b> <b>E20</b>	Error on the upper roller motor	▶ Press the arrow button to confirm.



Error	Cause	Troubleshooting
<b>E21</b>	Overcurrent on lower roller motor, possible foil wrapping	1. Open the lid and check the lower rollers. 2. If needed, remove the wrapped foil from the roller. 3. Close the lid.
<b>E22</b>	Error on the lower roller motor	▶ Press the arrow button to confirm.
<b>E23</b>	Error on the lower roller motor	▶ Press the arrow button to confirm.
<b>E24</b> <b>E25</b>	Safety Timer On	The error is automatically corrected by the system.
<b>E26</b>	Welding overcurrent	▶ Contact your dealer.
<b>E27</b>	Interruption of the welding current	▶ Contact your dealer.
<b>E28</b>	Overtemperature when welding	▶ Contact your dealer.
<b>E29</b>	Printed circuit board error	▶ Contact your dealer.
<b>E30</b>	Fan overcurrent	1. Press the arrow button to confirm. 2. Contact your dealer.
<b>E31</b>	Fan error	▶ Press the arrow button to confirm.
<b>E32</b>	No foil	1. Open the lid 2. Pull the foil 15 cm downwards. 3. Close the lid.



## 11. FAQ

! All FAQ & Information are available at [clesana.com](https://clesana.com).

### Can the bags be put in the compost (biowaste)?

No, the bags must be disposed of with the household waste. A biologically degradable variant is currently being evaluated.

### Can the bags be disposed of in commercially available waste containers (residual waste)?

Yes, unless there are separate regulations in this respect.

### Are the bags odour-proof?

In room temperature the bags are odour-proof for at least 2 weeks. With higher temperatures it is recommended to dispose of the bags within 2 days.

### Can I use the toilet again immediately after the triggering of the flushing process?

No, the previous "Flushing process" must be completed first. Opening the lid earlier can cause a malfunction.

### Can I weld other things in the bag?

Yes, basically biowaste, nappies or feminine hygiene products can be welded. However, no sharp-edged objects or hot ashes should be put in the bag. Note the maximum filling level!

### Does the toilet function only with a 12V voltage?

Yes, only this power supply is currently possible. Operation over mains voltage of 230 volts is not possible.

### How stable is the toilet?

The load-bearing capacity of the toilet with closed lid is 150 kg (sitting person).

## 12. Disposal and the environment

The Clesana C1 meets the requirements of EU Directive "Restriction of Hazardous Substances" (2002/95/EC). It is largely free of environmentally hazardous substances such as lead, cadmium, mercury or chromium VI.



In accordance with EU Directives, the device is considered electrical and electronic equipment waste for disposal purpose and must not be disposed of as household waste.

- Dispose of the device in accordance with local regulations.
- Dispose of the used batteries at the collection points provided for this purposes.

## 13. Technical specifications

Characteristic	Value	Unit
Height	515	mm
Width	363	mm
L-Adapter/round base length	516/461	mm
Seat height	478	mm
Weight of C1 with L-Adapter/with round base	13.8/13.1	kg
Supply voltage	11.8–15	V
Rated voltage	12	V
Current consumption (max.)	22	A
Power consumption in standby	0.28	W
Power consumption (max.)	265	W
Energy consumption in separation process	1.7 ±0.17	Wh
Energy consumption in welding process	0.55 ±0.06	Wh
Usage temperature	5–40	°C
IP protection class	X4 (splash water protection)	—

## Declaration of conformity

Manufacturer: Clesana AG  
Werdenstrasse 72  
9472 Grabs  
Switzerland

hereby declares that the following product

**Waterless toilet**  
**Clesana C1 Series**

based on the following applied standard:

- EN 50498-2010 EMC Aftermarket Electronic Equipments in Vehicles

meets the basic requirements of the following directives:

- 2011/65/EU RoHS 2
- Motor Vehicle EMC Directive 2004/104/EC

The product in question does not have any disruptive functions in accordance with Vehicle EMC Directive 2004/104/EG.

A handwritten signature in black ink, appearing to read 'M. Erb'.

---

**Signature**

Markus Erb  
Executive Director

---

Grabs, 20 December 2021

**Placer, date**

